

**ASSEMBLY INSTRUCTIONS:**

1. PREPARE CABLE ENDS, CONNECT TO CONNECTOR
2. SNAP JACKSCREWS INTO PLACE
3. PLACE CABLE IN STRAIN RELIEF RECESS AREA MAKING SURE CABLE JACKET IS BELOW STRAIN RELIEF. ENSURE THE CABLE IS PRESSED INTO THE STRAIN RELIEF RECESS AREA
4. PLACE CABLE CLAMP OVER CABLE. USING SCREWS PROVIDED, TIGHTEN CABLE CLAMP. CABLE CLAMP MAY BE INSTALLED UP SIDE DOWN FOR SMALLER CABLES
5. PLACE THE OTHER HALVE OF THE HOOD ON TOP OF THE FIRST HALF, MAKING SURE NO WIRES ARE PINCHED
6. TIGHTEN THE TWO HALVES TOGETHER WITH THE SCREWS PROVIDED

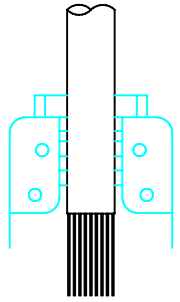

ITEM No. 3

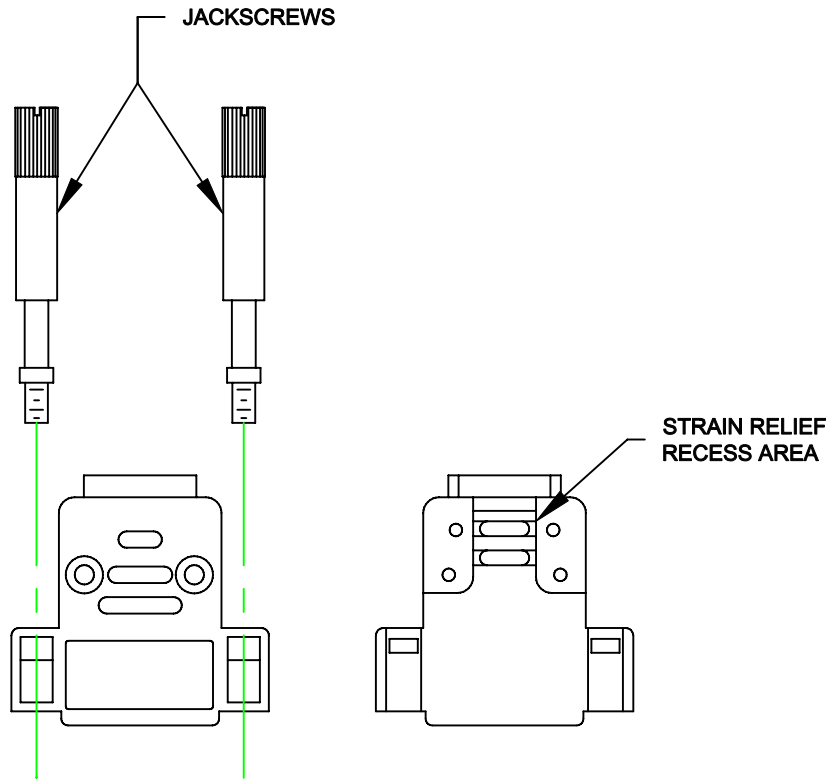
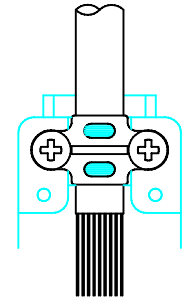

ITEM No. 4

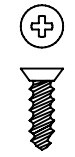

STRAIN RELIEF SCREW

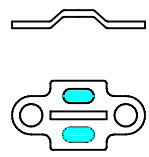

STRAIN RELIEF CLAMP

**RoHS COMPLIANT**

**PLASTIC**

	THESE DRAWINGS AND SPECIFICATIONS ARE THE PROPERTY OF NorComp AND SHALL NOT BE REPRODUCED, COPIED OR USED AS THE BASIS FOR THE MANUFACTURE OF SALE OF APPARATUS WITHOUT WRITTEN PERMISSION.		DRAWN: <b>C. SMITH</b>	DATE: <b>03-24-06</b>
			CHECKED: <b>X</b>	DATE: <b>X</b>
<h1>NorComp</h1>		SCALE: N.T.S.	SHEET 1 OF 2	REV 0
		DWG NO. <b>BACKSHELL - 973 SERIES</b>		

**ASSEMBLY INSTRUCTIONS:**

1. PREPARE CABLE ENDS, CONNECT TO CONNECTOR
2. SNAP JACKSCREWS INTO PLACE
3. PLACE CABLE IN STRAIN RELIEF RECESS AREA MAKING SURE CABLE JACKET IS BELOW STRAIN RELIEF. ENSURE THE CABLE IS PRESSED INTO THE STRAIN RELIEF RECESS AREA
4. IF CABLE IS SHIELDED, FOLD SHIELD AND/OR GROUND WIRE BACK OVER CLAMP AREA. CUT ANY EXCESS WIRE SO IT WILL NOT STICK OUT OF THE HOOD
5. PLACE CABLE CLAMP OVER CABLE. USING SCREWS PROVIDED, TIGHTEN CABLE CLAMP. CABLE CLAMP MAY BE INSTALLED UP SIDE DOWN FOR SMALLER CABLES
6. PLACE THE OTHER HALVE OF THE HOOD ON TOP OF THE FIRST HALF, MAKING SURE NO WIRES ARE PINCHED
7. TIGHTEN THE TWO HALVES TOGETHER WITH THE SCREWS PROVIDED

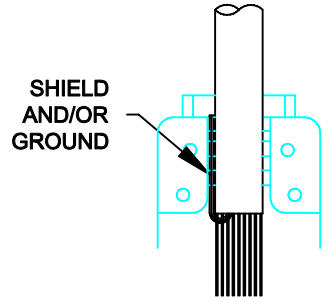
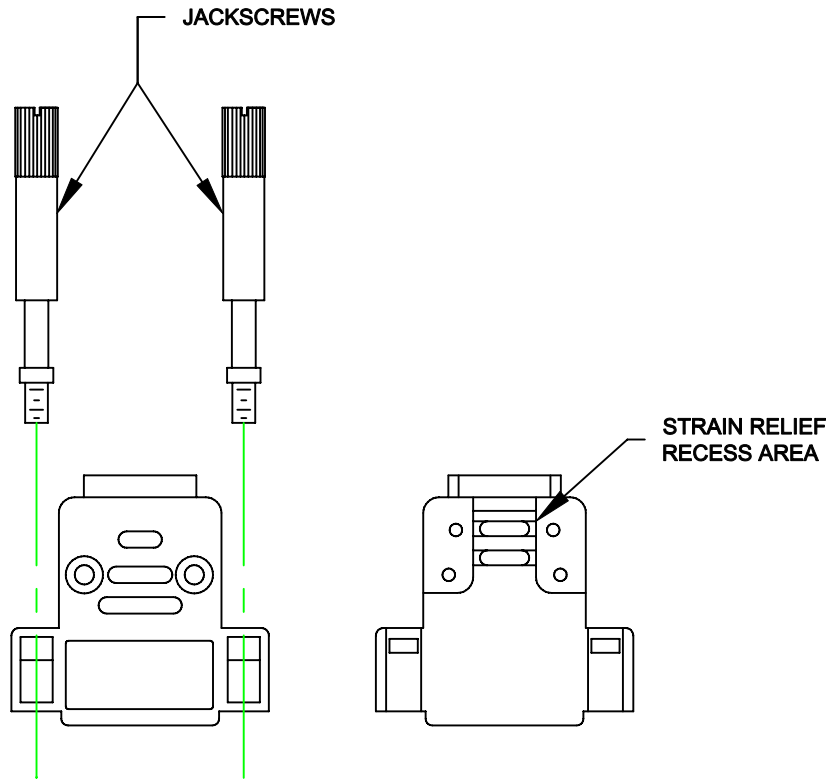

ITEM No. 3 & 4

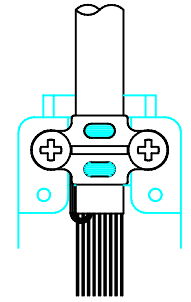

ITEM No. 5

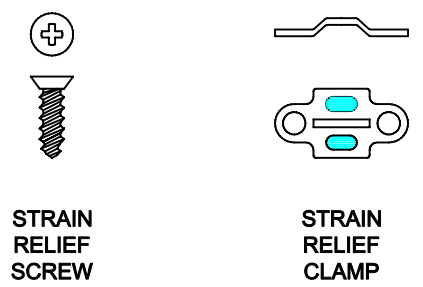

**RoHS COMPLIANT**

**METALIZED PLASTIC**

	THESE DRAWINGS AND SPECIFICATIONS ARE THE PROPERTY OF NorComp AND SHALL NOT BE REPRODUCED, COPIED OR USED AS THE BASIS FOR THE MANUFACTURE OF SALE OF APPARATUS WITHOUT WRITTEN PERMISSION.		DRAWN: <b>C. SMITH</b>	DATE: <b>03-24-06</b>
			CHECKED: <b>X</b>	DATE: <b>X</b>
<h1>NorComp</h1>		SCALE: N.T.S.	SHEET 2 OF 2	REV 0
		DWG NO. <b>BACKSHELL - 973 SERIES</b>		